

FMG		FMG 13 rue du clos d'en haut F 78700 Conflans Ste Honorine Tel. +33134900021 Fax +33134901566 contact@fmg-hydro.com	Dokument: D100485
Ausgestellt: 16-02-2006 Si	Geprüft: 29-11-2006 KK	Freigegeben: 29-11-2006 Si	Seite: 1/35

100485.doc

Operating Instructions

(Software version 2.03)

Moisture Processing Unit FMP-2

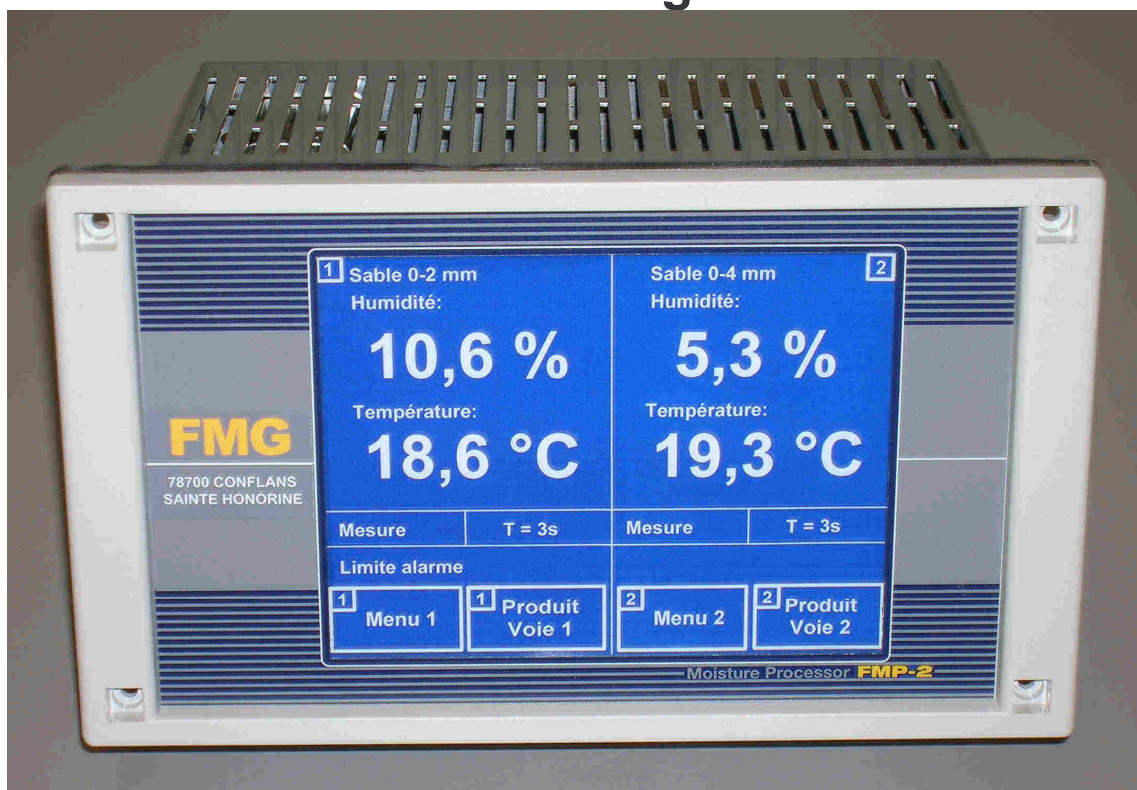

Figure 1: Moisture Processing Unit FMP-2 (two channel version)

Brief summary:

The FMP-2 is a processing and displaying unit, which, in combination with well proven FMG moisture sensors, processes the moisture and temperature of a material, displays the both quantities and and passes them to the process control.

The FMP-2 is not only processing the sensor signals, but also providing all needed supply voltages, so no additional supply unit is needed.

Up to two independend moisture sensors can be connected to the two channel version of FMP-2.

FMG	FMG 13 rue du clos d'en haut F 78700 Conflans Ste Honorine Tel. +33134900021 Fax +33134901566	Änderung:	Seite: 2/35	Dokument: D100485
------------	--	-----------	----------------	-----------------------------

100485.doc

The operation of FMP-2 is intuitive and simple and is supported by a big touch screen and high-resolution graphic display (LCD). Thanks to the use of modern SMD-technology the device is very compact.

Fife different calibration curves per channel with up to 40 calibration points each can be programmed by the help of an intuitive teach-in procedure. A linear interpolation is used between the calibration points.

All calibration points are comfortably stored and edited, either by entering the data by teach in of the calibration points, by calibration table or by directly moving the points in the displayed calibration curve on screen.

The moisture signal can also be displayed in the "Show Measure Curve" mode, like with the well known transient recorder, which can be very helpful during the first steps, when the FMP-2 is put into operation and during the calibration procedure.

Additionally, in „manual setting“ mode an control signal can be set and emitted by the output of FMP-2, to simulate certain moisture signals.

The FMP-2 is standardly emitting 0-10V, optionally 0-20mA or 4-20mA. The FMP-2 can communicate with the following process control also via the built-in USB- and RS485-interfaces.

Contents:

Chapter	Subject	Page
1	General points	5
2	Safety hints!	5
3	Ordering key	6
4	Different measuring modes of FMP-2	7
4.1	Measurement mode „measure“.....	7
4.2	Measuring mode „start/stop“.....	7
4.3	Measuring mode „automatic start/stop“.....	8
4.4	Start delay with the „start/stop“measuring modes.....	8
5	General notes on operation	9
5.1	Distinguishing between the channels.....	9
5.2	Unlocking of protected menus.....	9
5.3	Verification of successful unlocking.....	10
5.4	Storing the changes of settings.....	10
5.5	Some notes on „Range“.....	10
6	Summary of menus	11
7	Main menu	12
8	Channels average measurement	13
9	Submenu	14
10	Show measurement Curve	15
11	Manual setting	15
12	Product menu	16
13	Calibration menu	17
13.1	Unlocking the calibration menu	18
13.2	Curve initialisation.....	18
14	Options of calibration menu	19
14.1	Set up of calibration curve.....	19
14.2	Deleting a calibration curve.....	19
14.3	Entering of calibration points.....	20
14.4	Hints on calibration.....	20

FMG	FMG 13 rue du clos d'en haut F 78700 Conflans Ste Honorine Tel. +33134900021 Fax +33134901566	Änderung:	Seite: 4/35	Dokument: D100485
------------	--	-----------	----------------	-----------------------------

100485.doc

14.5	Three ways to enter the calibration points.....	20
14.5.1	Calibration by the help of „silo“ button („dynamic“ calibration).....	20
14.5.2	Calibration by the help of „0/3“ button („static“ calibration”).....	21
14.5.3	Entering a curve by the help of calibration table.....	21
14.6	„Calibration curve“ button in calibration menu.....	22
15	Settings menu	22
15.1	General notes.....	22
15.2	Setting options in the „Settings“ menu.....	23
16	Connecting of moisture sensors	26
17	Technical data	27
18	Installation hints	29
19	Panel assembly dimensions	29
20	Backside of FMP-2 / Pin assignment	30
21	Quickstart: Setting up a curve	31

FMG	FMG 13 rue du clos d'en haut F 78700 Conflans Ste Honorine Tel. +33134900021 Fax +33134901566	Änderung:	Seite: 5/35	Dokument: D100485
------------	--	-----------	----------------	-----------------------------

100485.doc

1. General points:

The second generation of FMG's Moisture Processing Unit „FMP“ is now available in a two channel version. Up to two independent moisture sensors can be connected to the FMP-2. More, up to two independent PT100-temperature sensors can be connected, mounted in the moisture sensors or external.

All cables are connected to the back plane of FMP-2 by the help of pluggable clamping bars. Standardly, the FMP-2 provides an USB-interface and a galvanically isolated RS485-interface, which allows the control of the FMP-2 and transmission of signals over very long distances (RS485).

2. Safety hints!

The FMP-2 is designed to be installed in a control console. So, the device doesn't contain a mains switch. The On-Off-switching must be provided by an external mains switch at the control console.

The device is only allowed to be opened by qualified personal! And only with unplugged mains cable, of course!

The device must be connected to mains by using a three wire cable, which includes the protective earth wire (PE)!

The FMP-2 is designed to be mounted into a switch panel. A rubber gasket supplied with FMP-2 seals the device at the switch panel. The back of enclosure contains vent openings and isn't waterproof!

The back of enclosure must be aerated to remove the internally dissipated heat. Because of this, other devices on the switch panel should not be mounted too close to the FMP-2.

The FMP-2 is protected against overload by self-resetting fuses (polyfuse).

3. Ordering key:**FMP2 - X - X - X - X - X****Type:**

FMP-2	Moisture Processing Unit FMP2	
--------------	-------------------------------	--

Mains Supply

230V	Mains voltage 230V AC	
115V	Mains voltage 115V AC	

One or two channels

M	One channel version (monodevice)	
D	Two channel version (duodevice)	

Moisture input

U	Signal inputs (moisture) „0-10V“ (standard)	
I	Signal inputs (moisture) „0-20mA“	
I4	Signal inputs (moisture) „4-20mA“	

Moisture output

U	Signal outputs (moisture) „0-10V“ (standard)	
I	Signal outputs (moisture) „0-20mA“	
I4	Signal outputs (moisture) „4-20mA“	

Temperature Modul for PT100

UT	Signal outputs (temperature) „0-10V“ (standard)	
IT	Signal outputs (temperature) „0-20mA“	
I4T	Signal outputs (temperature) „4-20mA“	

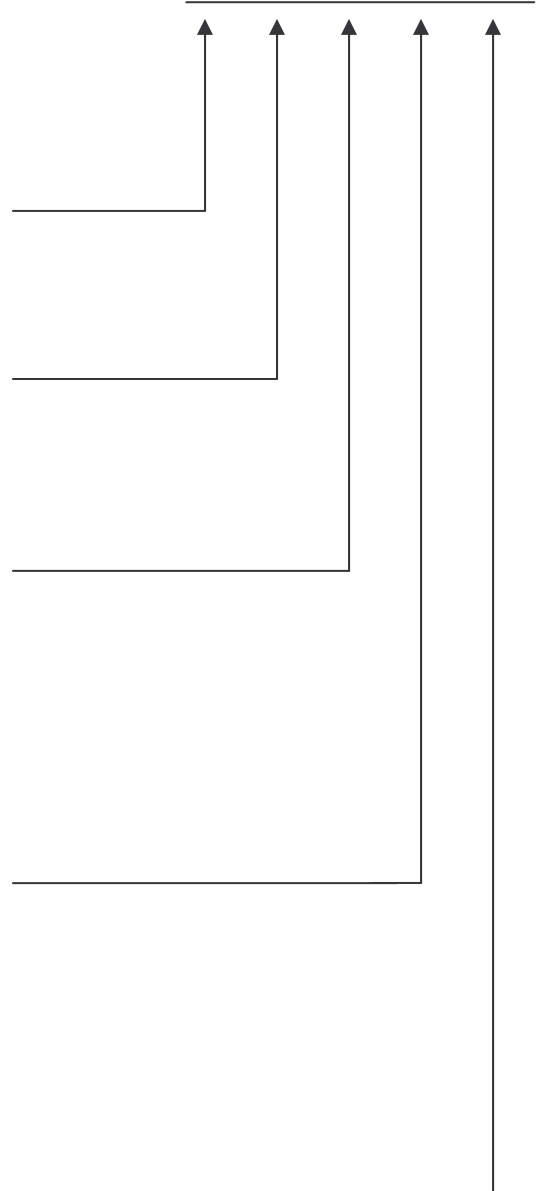

FMG	FMG 13 rue du clos d'en haut F 78700 Conflans Ste Honorine Tel. +33134900021 Fax +33134901566	Änderung:	Seite: 7/35	Dokument: D100485
------------	--	-----------	----------------	-----------------------------

100485.doc

Example: **FMP2-230V-D-U-I4-X**

FMP2: Moisture processing unit FMP-2

230V: Mains voltage: 230V AC

D: Duodevice, means two channel version („M“ would be „monodevice“)

U: Both sensor signal inputs (moisture) „0-10V“

I4: Both signal outputs (moisture) „4-20mA“

X: No temperature option („X“ can be omitted here)

4. Different measuring modes of FMP-2:

The FMP-2 is available as one channel version (monodevice) or as two channel version (duodevice). The operation of both devices is identical.

The desired “Measure Mode” is chosen in the „Settings“ menu:

4.1 Measuring mode „measure“:

In this factory presetting mode the moisture is continuously measured and displayed in real-time. If the display reading appears unstable a signal filtering (moving average time) can be added.

4.2 Measure-mode „start/stop“:

The FMP-2 provides independent and galvanical isolated start/stop switch inputs for each channel. The measurement is controlled by this input: 0V = stop and +24V = start.

The status of the according switch input is displayed in the status line of „main menu“.

This useful feature allows to measure the moisture during a certain period of time, for instance for the duration of dosage.

Immediately after the start signal has become active (+24V = start) the measurement of moisture begins. For the whole duration of dosage the FMP-2 continuously calculates the current average value of moisture and displays it.

Immediately after the switch input has become inactive again (0V = stop), the measurement stops and the last calculated average value is permanently displayed, until a new start signal arrives. Also, at the signal output of the FMP-2 the last calculated average value is permanently emitted.

FMG	FMG 13 rue du clos d'en haut F 78700 Conflans Ste Honorine Tel. +33134900021 Fax +33134901566	Änderung:	Seite: 8/35	Dokument: D100485
------------	--	-----------	----------------	-----------------------------

100485.doc

By other words, the start-stop-feature allows to measure the averaged moisture during a certain period of time. Afterwards the calculated average value can be taken over by the process control.

As long as the last average value is captured, the status line on screen displays „stop + hold“.

FMG	FMG 13 rue du clos d'en haut F 78700 Conflans Ste Honorine Tel. +33134900021 Fax +33134901566	Änderung:	Seite: 9/35	Dokument: D100485
------------	--	-----------	----------------	-----------------------------

100485.doc

4.3 Measuring mode „automatic start/stop“:

In this measuring mode the FMP-2 also continuously calculates the current average value of moisture for the whole duration of dosage, but here the measurement is not controlled by the switch input but by the moisture signal itself. When there's no material at the sensor before and after the period of dosage, but only during the dosage, then the begin and end of material flow can easily be detected from the height of moisture signal: When there's no material at the sensor, then the moisture signal is nearly 0%, of course. So, everything to do is to choose a suited threshold, so that the measurement is started, whenever the moisture signal is higher than the threshold and is stopped, whenever the signal is smaller than the threshold.

This measuring mode is highly useful, when the sensor is mounted below the dosage outlet of a silo, for instance.

A suited threshold for this automatic start/stop, called „lower signal limit“, can be set in the „stettings“ menu.

During the measurement the message „auto start“ is displayed in the status line of the „main menu“. At the end of the measurement the last calculated average value is permanently displayed, until a new start signal arrives. Also, at the signal output of the FMP-2 the last calculated average value is permanently emitted. As long as the last average value is captured, the status line on screen displays „stop + hold“.

4.4 Start delay with the measuring modes „start/stop“ and „automatic start/stop“:

In the „Settings“ menu you can additionally set a start delay time, which causes, that the measurement does not begin immediately after activation of start signal, but only after the end of this start delay time.

The start delay helps to eliminate irregularities of material flow immediately after the start, for instance.

Or you can suppress a certain „dead time“, means the period of time the material eventually needs to flow to the sensor.

5. General notes on operation:

5.1 Distinguishing between the channels:

In each display window there is on top of the screens a small symbol (number „1“ or „2“, in a small square), which informs about being in a menu of channel 1 or channel 2. Here is an example: You see the „main menu“ of two channel version of FMP-2:

Left side is for channel 1 and right side is for channel 2.

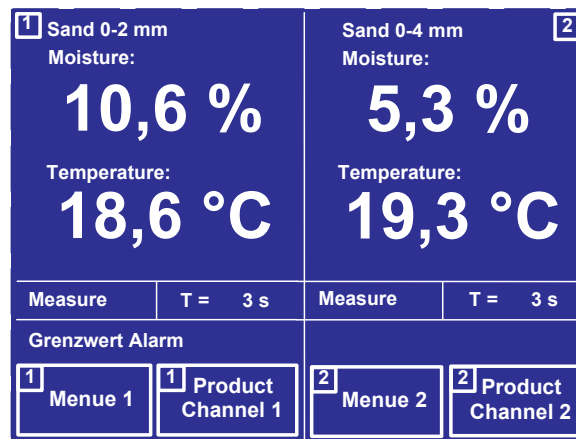

Figure 0: „Main menu“ of two channel version

5.2 Unlocking of protected menus:

To protect important settings of FMP-2 against unintentional misadjustment, most of the settings are locked. To change a certain setting you must first unlock the menu by a certain sequence of keystrokes:

1.) Unlocking in the „EDIT“ menu:



figure 2

2.) Unlocking in the „Settings“ menu:



figure 3

FMG	FMG 13 rue du clos d'en haut F 78700 Conflans Ste Honorine Tel. +33134900021 Fax +33134901566	Änderung:	Seite: 11/35	Dokument: D100485
------------	--	-----------	-----------------	-----------------------------

100485.doc

First, press the left arrow button (-), then the right arrow button (+), again the left arrow button (-) and again the right arrow button (+).

5.3 Verification of successful unlocking:

In the „Settings“ menu:

The first setting in this menu becomes highlighted. Press the cursor buttons to choose the settings you want to change.

In the „EDIT“ menu:

New push buttons appear in the „EDIT“ menu.

Without unlocking the calibration curves can only be displayed, but not changed. You need to unlock the menu to be able to make changes of calibration.

5.4 Storing the changes of settings:

You must always press „ENTER“ to store the change of each setting.

5.5 Some notes on „Range“:

When setting up a new calibration curve in the „Curve initialisation“ menu you must always set the according „Range“. The „Range“ defines the maximum range of moisture of this calibration curve. The „Range“ also defines the moisture at maximum output signal of FMP-2. Example: A Range of 20% in combination with a signal output of 0-10V gives 0V at a moisture of 0% and 10V at a moisture of 20%. Between these limits the signal linearly increases by 0.5V every 1% increase of moisture.

The same when the output emits a current of 0-20mA.

When emitting a current of 4-20mA, then 0% corresponds to 4 mA und 20% to 20 mA, linearly increasing.

Finally, the „scale“ also determines the available range for the signal limits and alarm thresholds in the „Settings“ menu:

100485.doc

6. Summary of menus:

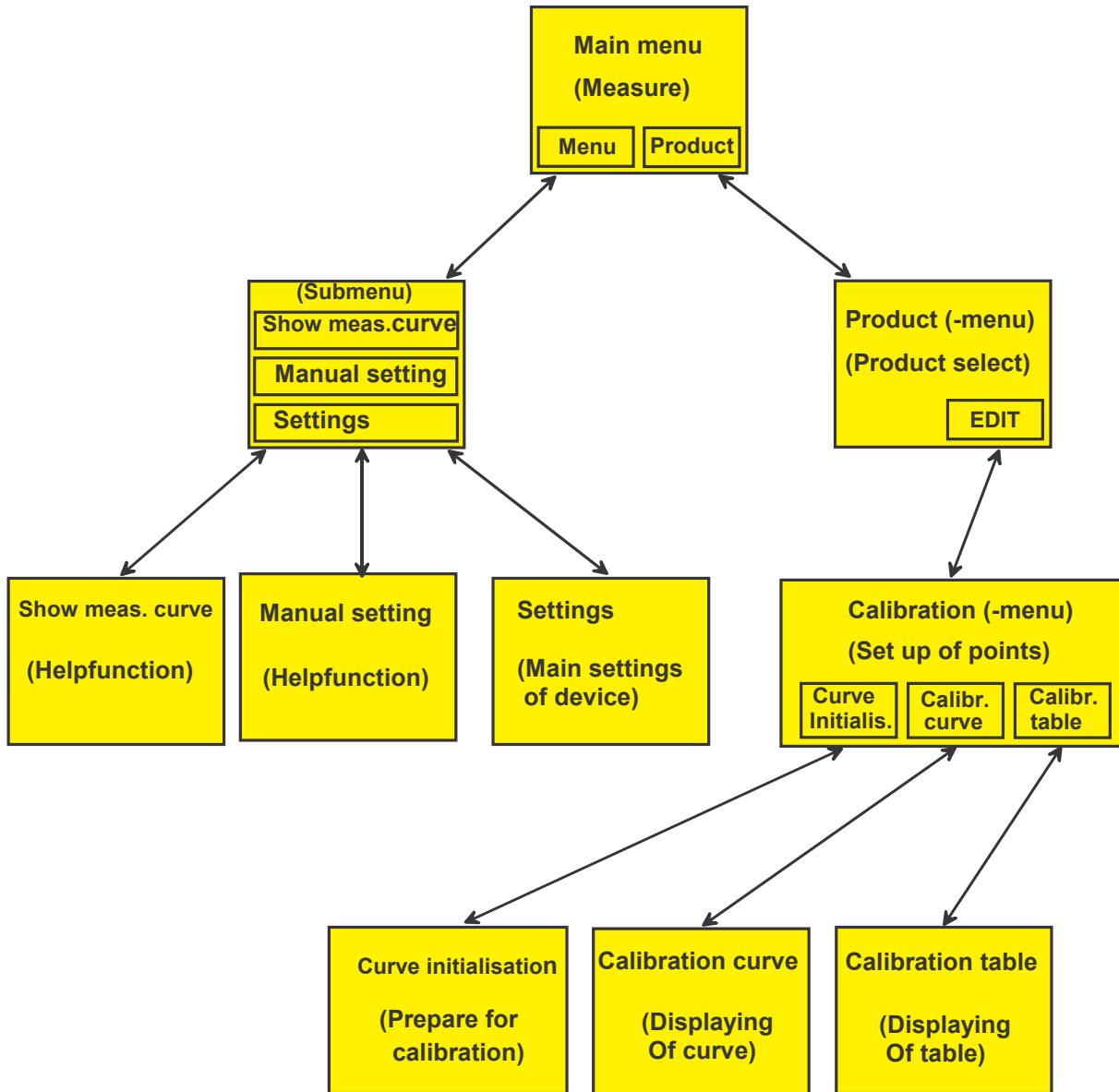

(By pressing „ESCAPE“ you get always back to the former menu.)

According to the above figure, there are the following menus:

Main menu

Standard display window of the measuring.

Submenu

For selecting the menus „Show measure curve“, „Manual settings“ and „Settings“.

100485.doc

<i>Show measure curve</i>	Displaying like a transient recorder. Very clear graphical method for displaying the measured moisture signal over a time window, helping a lot during the calibration, when the FMP-2 is put into operation.
<i>Manual setting</i>	Feature, which allows the output signal to be set by hand.
<i>Settings</i>	In this menu important main settings are handled.
<i>Product</i>	Product select menu to select one of the available products. Pressing the „EDIT“ button in this menu allows you to go to „calibration“ menu, where curves can be edited.
<i>Calibration</i>	In this menu the calibration curves of the products are stored and edited. Being in the „main menu“ you can reach the „calibration“ menu by pressing the buttons „product“ and then „EDIT“.
<i>Curve initialisation</i>	Setting up of curves by editing the name of the curve and range.
<i>Calibration curve</i>	Displaying of available calibration curves. Editing of calibration points.
<i>Calibration table</i>	Displaying of calibration points or editing of calibration tables.

7. Main menu:

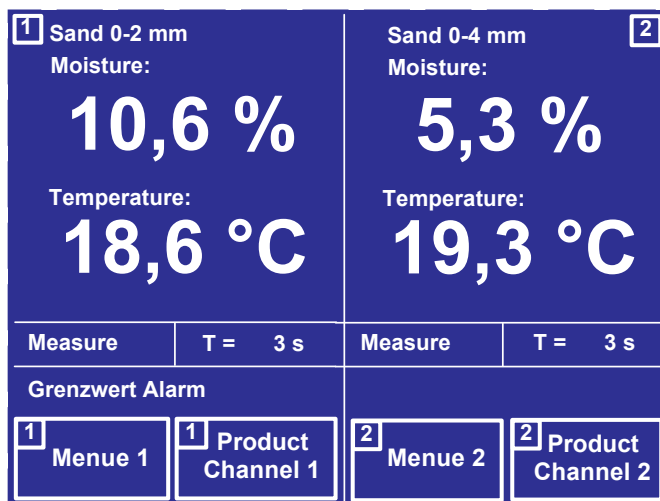

Figure 4: „Main menu“ of two channel version

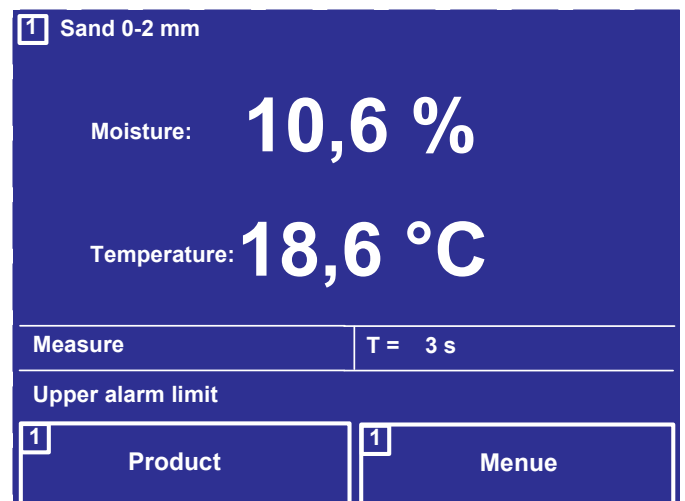

Figure 5: „Main menu“ of one channel version

The „main menu“ is also the standard display window of the measuring. Here, the moisture and temperature is displayed.

FMG	FMG 13 rue du clos d'en haut F 78700 Conflans Ste Honorine Tel. +33134900021 Fax +33134901566	Änderung:	Seite: 14/35	Dokument: D100485
------------	--	-----------	-----------------	-----------------------------

100485.doc

The „main menu“ display window of the two channel version is divided into two identical halves. Left side for channel 1 and right side for channel 2.

At the top of display window the name of selected curve, means the product is displayed. The editing of curve name, means product, is done in the „calibration“ menu.

When there are still no calibration curves available, means after the first power-on of FMP-2, then the voltage (or current) measurement of sensor signal is automatically selected (default). Because there is no calibration curve available then, no moisture can be displayed at this moment, of course. In this case the sensor signal is displayed in V (or mA). (See also „12. Product menu“)

If there's no temperature sensor connected to the FMP-2 (or no temperature option is available), no temperature is displayed.

Below the measured values the measuring mode and the signal average time is displayed for each channel.

Below of that you will find the status lines. Here status and error messages (alarms) are displayed, again independently for each channel.

Right at the bottom you will find the four buttons „menu 1“, „product channel 1“, „menu 2“ and product channel 2“.

By pressing the „menu“ buttons you can reach a submenu, from where you can go into three further submenus: „Show Measure Curve“, „Manual Settings“ and „Settings“.

By pressing the „Product“ buttons you will enter the „Product“ menu, where you can select one of five calibration curves per channel and where you can select the help function „voltage measurement“ (current measurement). From here you can reach the „calibration“ menu, by pressing the „EDIT“ button.

8. Channels average measurement:

If both moisture sensors are mounted at the same silo, for instance, and you are interested in the average moisture signal from both moisture sensors, then you can activate the displaying of average value from both channels in the „main menu“. At the same time also the average temperature signal from both temperature sensors is displayed.

100485.doc

To activate the displaying of average value from both channels, set „channels average measurement = ON“, in the „Settings“ menu.

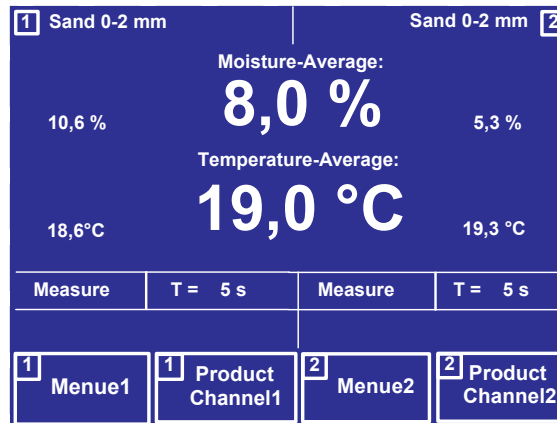

Figure 6: Channels average measurement in the „main menu“

9. Submenu:

You can reach the submenu, when pressing the button „**Menu 1**“ or „**Menu 2**“ in the „main menu“.

Here you can select the following menus:

<i>Show measure Curve</i>	Displaying like a transient recorder, clear methode of displaying
<i>Manual setting</i>	Feature, which allows the output signal to be set by hand
<i>Settings</i>	In this menu important main settings are stored
<i>ESCAPE</i>	Going back to the former menu

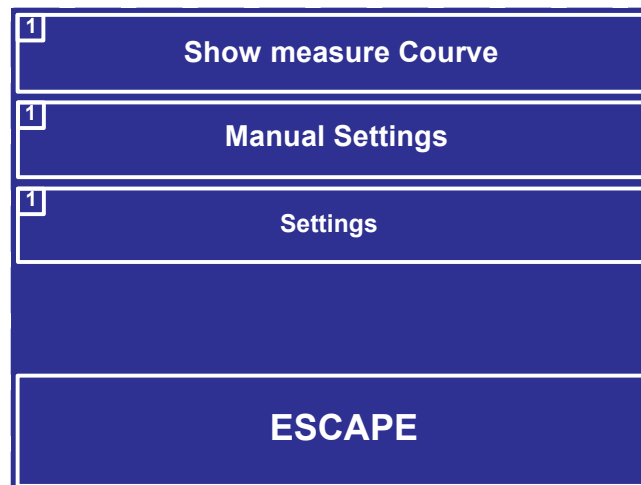

Figure 7: Submenu

10. Show measurement curve:

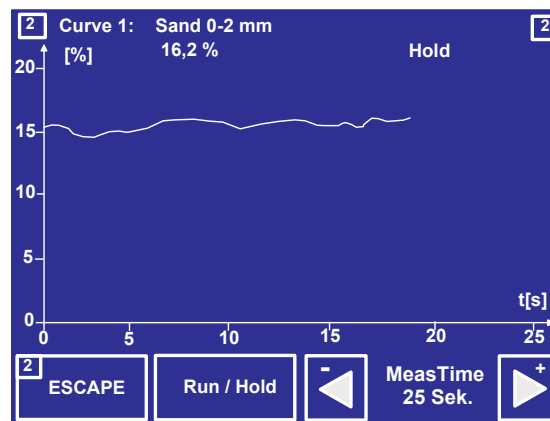

Figure 8: Recording mode

For the selected channel the moisture signal can be displayed in a similar way as a transient recorder does. Here, the signal „runs“ from the left side to right side on screen. Having reached the right side, the signal starts again at the left side. The time period needed to run from the left to the right side can be set by the two arrow buttons for 5, 25, 50 and 100 seconds.

This option allows to display the moisture signal in an easy way during the whole dosage period and helps to analyze the dosage process.

You can stop the measurement at any time by pressing the „**RUN / Hold**“ button. At this moment the symbol „hold“ begins to blink and the last reading remains „frozen“. Press again the „Run / Hold“ button and the measurement continues.

This displaying option, by the way, helps to find an optimum averaging time constant, if any needed.

11. Manual setting:

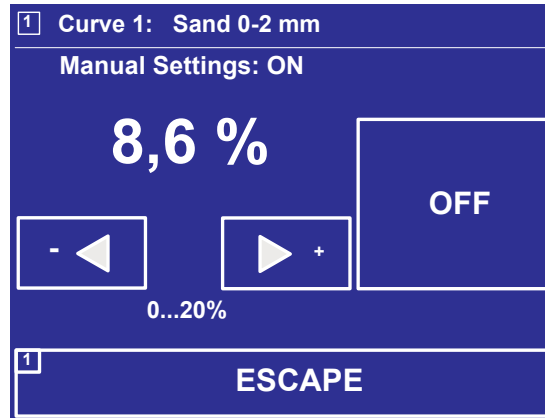

Figure 9: „Hand setting“ menu

This option allows to set a moisture signal by hand and emit it at the output of FMP-2 (0-10V or 0/4-20mA, whatever is available).

Standardly the output emits the measured moisture signal. But when the „Manual setting“ is activated, the output emits the value set by hand.

In this case the moisture sensor signal is only displayed in the „main menu“.

The hand setting option allows to simulate certain measuring situations and helps to analyze and optimize the process control.

This option also allows to send a signal to the process control, if the sensor is disconnected for inspection purpose, or similar. Or you can calibrate the input of an A/D-converter of process control, for instance.

To remember the operator that the signal is set by hand, in the „main menu“ in the status line the warning „hand setting = X%“ is displayed.

When a sensor is connected to the FMP-2, in the „main menu“ the sensor signal is displayed, but the output will emit the value set by hand.

In the „hand setting“ menu there are four buttons: Two buttons to set the hand value, the button to activate and deactivate the hand setting and the „ESCAPE“ button.

12. Product menu:

100485.doc

The „product“ menu can be reached from the „main menu“ by pressing the button **„Product channel 1“** (or „Product channel 2“). From here you can select the product (selection of according calibration curve).

1	Product:	scale range:
	Sand 0-2 mm	20%
	Grain	40%
	Sand 0-4 mm	20%
	not occupied	
	not occupied	
1	Voltage measure (Voltage)	
1	ESCAPE	1 EDIT

Figure 10: „Product“ menu

There are five product select buttons which carry the product names. A non-configured curve is called „not-occupied“. To each product there is the range displayed at the right side. „Range“ means here the maximum range of moisture.

There is also the button **„Voltage measurement“** („Current measurement“). When pressing this button, the sensor signal is directly displayed in „V“ or „mA“. This status is also displayed in the „main menu“. This feature is very interesting for preadjustment of the sensor signal range.

Press the **„ESCAPE“** button to go back to the „main menu“.

Press the **„EDIT“** button to go to the „calibration“ menu (to the curve you have selected by the product button).

13. Calibration menu:

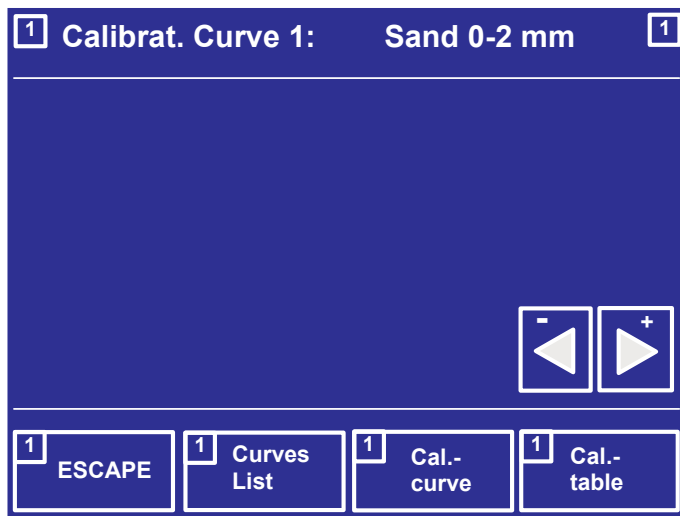

Figure 11: Locked „calibration“ menu

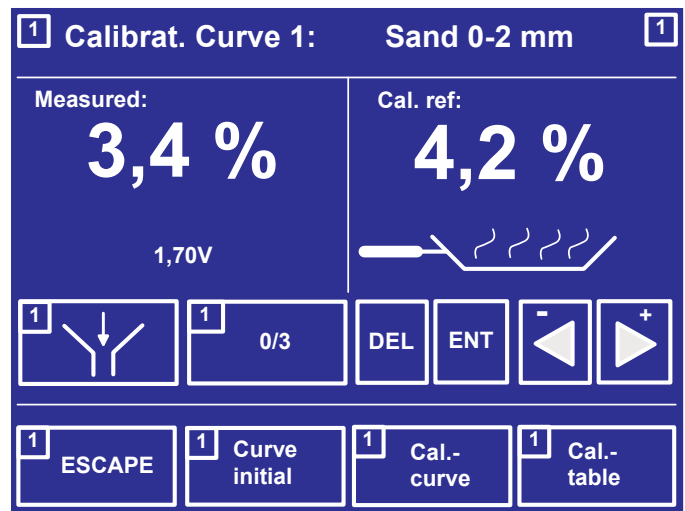

Figure 12: Unlocked „calibration“ menu

From the „main menu“ you can reach the „product“ menu by pressing the button „**Product channel 1**“ (or „product channel 2“). In this menu a calibration curve can be selected by pressing a product button. From here you can enter the „calibration“ menu by pressing the „**EDIT**“ button to edit the selected calibration curve. In this menu you can also set up new calibration curves or delete existing ones.

13.1 Unlocking the „calibration“ menu:

When pressing the „**EDIT**“ button you will enter the locked „calibration“ menu (see figure 11). „Locked“ means, that the curve list, the selected calibration curve and the curve table is visible, but that you cannot change any calibration data.

In the locked „calibration“ menu some buttons are missing, which become visible in the unlocked „calibration“ menu (see figure 12)

To unlock the „calibration“ menu a certain sequence of keystrokes is needed, as already mentioned above:

First, press the left arrow button (-), then the right arrow button (+), again the left arrow button (-) and again the right arrow button (+).

Afterwards the unlocked „calibration“ menu appears, according to figure 12.

FMG	FMG 13 rue du clos d'en haut F 78700 Conflans Ste Honorine Tel. +33134900021 Fax +33134901566	Änderung:	Seite: 20/35	Dokument: D100485
------------	--	-----------	-----------------	-----------------------------

100485.doc

The unlock feature shall prevent important settings from being changed by non authorized persons.

Leaving the „calibration“ menu will automatically activate the lock again.

13.2 Curve initialisation:

Before entering calibration points you must first configure a new curve by pressing the „Curve initialisation“ button in the unlocked „calibration“ menu.

„Curve initialisation“ means to enter a curve name (e.g. sand 0-4mm) and to enter the preferred range of moisture (e.g. 20%).

Calibration curves are configured in the „calibration“ menu and can also be edited and displayed here. Optionally, calibration curves can also be entered and edited by the help of calibration table.

Each calibration curve can contain up to 40 different calibration points. Between the points a piece wise linearization is provided, means neighboured points are connected by a straight line (see figure 14).

In the „calibration“ menu the calibration curve is preselected, which was formerly selected in the „product“ menu. But it is also possible to select another curve in the menu “Curve initialisation”.

14. Options of calibration menu:

14.1 Set up of calibration curve:

Press the „**Curve initialisation**“ button (figure 12). The „Put calibration curve“ menu appears. You can see now a table consisting of three columns (curve-no. (1-5), curve name (e.g. sand 0-2 mm), Range (e.g. 20%) and some buttons.

Put calibration curve		
Curve	Calibr.curve name	Range
1	Sand 0-2 mm	20 %
2	Sand 4-8 mm	20 %
3	Coffee green	10 %
4		
5		

Navigation buttons: Up, Down, +, Right, ESCAPE, DEL, ENTER, ABC, Left.

Figure 13: „Curve initialisation“ menu

You can do two things in this menu:

1. You can enter the curve name and range, means you can initialise a new curve.
2. You can delete complete curves.

Move the cursor by the help of **right/left** buttons.

To enter the curve name press the „**ABC**“ button. To enter the range press the „**123**“ button.

This button is displayed if the cursor is in the field “Range”. After entering of each data press the „**ENTER**“ button. Then, back in the „Curve initialisation“ menu, press again the „**ENTER**“ button.

Now you can enter the calibration points. A curve needs at least two calibration points.

14.2 Deleting a curve:

You can delete a curve in the „Curve initialisation“ menu. Take care, deleting a curve eliminates all data of this curve, means the curve is entirely deleted!

To delete the curve move the cursor to the desired curve number at left side of the screen.

Now press the „**DEL**“ button. You can undo the deletion by the help of „**UNDO**“ button!

Attention: You must press the „**UNDO**“ button immediately after the „**DEL**“ button to undo the deletion.

FMG	FMG 13 rue du clos d'en haut F 78700 Conflans Ste Honorine Tel. +33134900021 Fax +33134901566	Änderung:	Seite: 22/35	Dokument: D100485
------------	--	-----------	-----------------	-----------------------------

100485.doc

14.3 Entering the calibration points:

Attention: Before entering the calibration points the moisture sensor itself must be precalibrated, so that the signal range is within 0-10V (0/4-20mA) for the desired scale.

14.4 Hints on calibration:

First, a static calibration of FMP-2 by the help of prepared buckets containing material of well known moisture has to be carried out. This „static“ calibration curve can be optimized by a „dynamic“ calibration later, when the sensor is mounted in its final application and further calibration points are added.

The graph of calibration curve can help to find optimum calibration points: A proper calibration curve isn't angular but smooth!

14.5 Three ways to enter the calibration points:

In the „calibration“ menu there are the following three ways:

14.5.1 Calibration by the help of „silo“ button („dynamic“ calibration):

By the help of „silo“ button (left of „0/3“ button in figure 12) an averaged calibration point can be gained, which is taken during the dosage process. For this, press the „silo“ button as long as the dosage process lasts. But start the pressing only when the material has begun to flow evenly and stop the pressing before the dosage process ends. By this, a representative measurement during the whole dosage process is guaranteed.

The calibration by the help of „silo“ button provides very reliable calibration points. While the „silo“ button is pressed, at the left side of screen the averaged value is displayed. When the button is released, the final average value is displayed in big letters. At the same time at the right side of screen the „ Calibration reference “ is displayed. Enter the reference moisture (calibration point) by the help of arrow buttons and press the „**ENT**“ button to store the data. The calibration point can be changed later, by changing the entries of according calibration table.

FMG	FMG 13 rue du clos d'en haut F 78700 Conflans Ste Honorine Tel. +33134900021 Fax +33134901566	Änderung:	Seite: 23/35	Dokument: D100485
------------	--	-----------	-----------------	-----------------------------

100485.doc

14.5.2 Calibration by the help of „0/3“ button („static“ calibration):

By the help of „0/3“ button (see figure 12) you can generate a calibration point by taking the average of up to three measurements in a row. This option is very useful, if the moisture measurement of a certain material is difficult, means if it depends on how you prepare the sample (surface) or how you press the sensor onto the sample. So, when you have the samples in buckets you should use the this calibration mode.

If the average shall be taken from only one or two measurements, press the „**ENT**“ button to leave the taking of samples. Afterwards, at the right side of screen the „Calibration reference“ is displayed. Enter the reference moisture (calibration point) by the help of arrow buttons and press the „**ENT**“ button to store the data. The calibration point can be changed later, by changing the entries of according calibration table.

14.5.3 Entering a curve by the help of calibration table:

Press the „**Calibration table**“ button to enter the „calibration table“ menu.

You can enter, change and edit all the table data by the arrow buttons. Each change of data must be stored by pressing the „**ENTER**“ button.

After pressing the „**ENTER**“ button the data of table is automatically arranged according to size.

By pressing the „**DEL**“ button you can delete a calibration point. You can undo the deletion by the help of „**UNDO**“ button. Take note, that you must press the „**UNDO**“ button immediately after the „**DEL**“ button to undo the deletion!

14.6 „Calibration curve“ button in „calibration“ menu:

To enter the „calibration“ menu (see figure 14) press the „**Calibration curve**“ button:

100485.doc

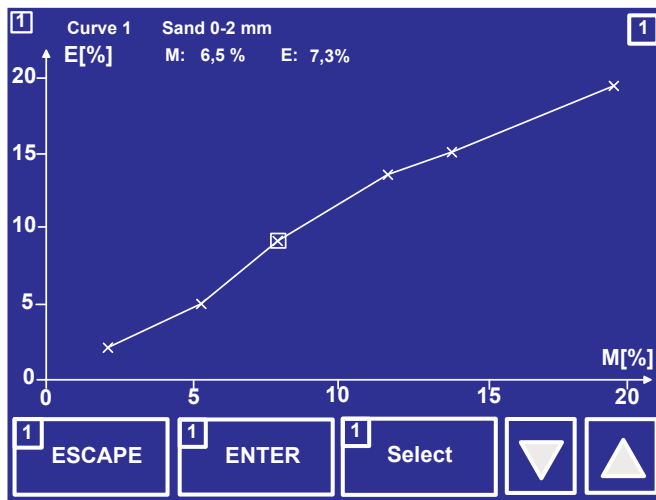

Figure 14: Selecting of calibration point

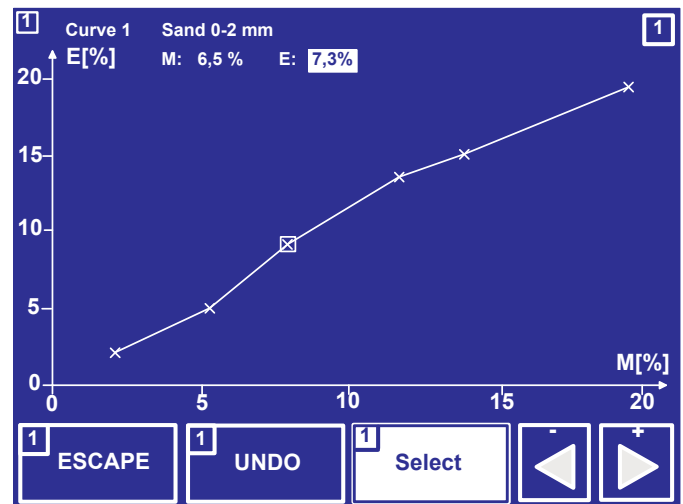

Figure 15: Editing of calibration point

In this menu the graph of calibration curve is displayed. You can directly change the calibration points of the graph: Select a certain calibration point by the help of arrow buttons, press the „**Select**“ button and move this calibration point up or down by the help of arrow buttons. To store the change, press the „**ENTER**“ button.

In the „calibration curve“ menu no calibration points can be added or deleted.

15. Settings menu:

15.1 General notes:

To enter the „settings“ menu press the „**Menu**“ button in the „main menu“ and then the „**Settings**“ button.

In this menu important main settings of the FMP-2 are stored.

Attention: Like the „calibration“ menu this menu is locked, to prevent important settings from being changed unintentionally. To change the settings, the menu must first be unlocked by a certain sequence of keystrokes:

First, press the left arrow button (-), then the right arrow button (+), again the left arrow button (-) and again the right arrow button (+).

FMG	FMG 13 rue du clos d'en haut F 78700 Conflans Ste Honorine Tel. +33134900021 Fax +33134901566	Änderung:	Seite: 25/35	Dokument: D100485
------------	--	-----------	-----------------	-----------------------------

100485.doc

By the help of arrow buttons you can select and edit the settings. To store the changes please press the „**ENTER**“ button.

15.2 Setting options in the „Settings“ menu:

- Software version:** The software can be updated in the future by the help of an internal connector.
- Language:** You can select the following menu languages: German, english, french and spanish. Other languages possible.
- Averaging time:** Settable from 0 to 100 seconds. The averaging time plays only a role with the continuous measuring. With the start/stop and automatic start/stop measuring modes the average is taken over the whole dosage period , of course.
- Measure-mode:** Three measuring modes are available:
Measure (continuous measurement)
Start / stop (activation via external switch input: start = +24V, stop = 0V)
Automatic Start / Stop (Activation when reaching a certain threshold).
- Start delay:** Only available with the measuring modes „start / stop“ and „automatic start / stop“. The start of measurement is delayed by the start delay time.
Possible settings: 0.1...0.9...1...100 seconds.
The start delay helps to eliminate irregularities of material flow immediately after the start, for instance. Or you can suppress an eventual „dead time“, means the period of time the material needs to reach the sensor.

FMG	FMG 13 rue du clos d'en haut F 78700 Conflans Ste Honorine Tel. +33134900021 Fax +33134901566	Änderung:	Seite: 26/35	Dokument: D100485
------------	--	-----------	-----------------	-----------------------------

100485.doc

Channels averaging: On / Off. Only available with the two channel version.
When being activated the moisture and temperature measurement is the average from both channels.

Signal limits:

By the help of signal limits you can limit the displayed and emitted value of moisture measurement.

Assume the range was set to 20%, then the range of moisture measurement is 0-20%. By the help of signal limits you can now furtherly limit the displayed and emitted value of moisture measurement: If you set the lower signal limit to 3%, for instance, then a sensor signal in the range of 0...3% will result in a reading of 3%.

The same with the upper signal limit: If you set the upper signal limit to 16%, for instance, then a sensor signal in the range of 16...20% will result in a reading of 16%.

By other words, the signal limits allow to limit the signal emitted at the output of FMP-2 and to limit the displayed value of moisture measurement.

For each curve a lower and an upper signal limit can be set.

Alarm limits:

By the help of alarm limits you can set certain thresholds, which activate individual alarms when being exceeded. These alarms are not only displayed in the status line of „main menu“, but can also activate the alarm relays.

For each curve a lower and an upper alarm limit can be set.

Assigning of alarm relays:

The FMP-2 contains two independent alarm relays. Both relays can be assigned to both channels and to all alarms.

Following alarms are available:

Low-Lim	Lower Limit
	Exeeding of lower signal limit

FMG	FMG 13 rue du clos d'en haut F 78700 Conflans Ste Honorine Tel. +33134900021 Fax +33134901566	Änderung:	Seite: 27/35	Dokument: D100485
------------	--	-----------	-----------------	-----------------------------

100485.doc

Hi.-Lim	Higher Limit Exeeding of upper signal limit
L/H-Lim	Lower Limit / Higher Limit Combination of alarms LL and UL
Temp	Temperature alarm Exeeding of temperature limit
Low-AI	Lower Alarm Limit Exeeding of lower alarm limit
High-AI	Higher Alarm Limit Exeeding of upper alarm limit
L/H-AI	Lower / Higher Alarm Limit Combination of alarms Low-AI and High-AI

Hint:

Maximum rating of galvanic isolated relay contacts: 60V / 1A.

Temperature limit:

(Only available with temperature option)

Temperature alarm when exeeding: **80°C** (default setting)

100485.doc

Temperature compensation:

(Only available with temperature option)

Temperature compensation: **Off** (default setting)

Mat. Temp.	Moist. Correction
20 °C	0,00 %
50 °C	0,00 %
80 °C	0,00 %

The above table helps to provide a temperature dependend correction of moisture, means a temperature compensation of measurement.

A second order curve is calculated from the table data and is added to the measured moisture.

To activate the temperature compensation, set „Temperature compensation to **“On“**.

Because the temperature effect on moisture measurement is rather little, there’s only one temperature compensation table available for all the products (calibration curves). The temperature compensation can be turned-on or –off.

Keyboard-Buzzer: On On / Off of beeper

Display-Brightness: 90% Setting of brightness (20%-100%)

Display-Contrast: 62% Setting of contrast (50%-100%)

16. Connecting of moisture sensors:

Two FS... moisture sensors can be connected to the two channel version of FMP-2. These sensors must contain the trimmers „0“ and „%“ (option „-T-“) to allow a precalibration of these sensors for the desired material.

FMG	FMG 13 rue du clos d'en haut F 78700 Conflans Ste Honorine Tel. +33134900021 Fax +33134901566	Änderung:	Seite: 29/35	Dokument: D100485
------------	--	-----------	-----------------	-----------------------------

100485.doc

17. Technical data:

Mains power:

Available options: Standard: 230V AC $\pm 10\%$, 50-60 Hz, max. 16VA
Optional: 115V AC $\pm 10\%$, 50-60 Hz, max. 16VA

mains connector: 3-pole IEC power connector, on the backside

Operating environment:

Temperature range: Operation: -5 bis $+45^{\circ}\text{C}$

Moisture sensors:

Powering: $\pm 15\text{V}$ (tolerance $\pm 0,5\text{V}$), shortproof
also sensors for 9-30V DC at +15V connectable

Current consumption per sensor: -15V: 50mA max.
+15V: 120mA max.

Signal input: 0-10V (0/4-20mA optional), protected
Input must be set to „U“ or „I“, depending on signal emitted by the sensor

Connection: Pluggable clamping bar (X1=channel 1, X2=channel 2)

Temperature sensors:

Type: PT100

Technique: 4 wire, shielded

Connection: Pluggable clamping bar (X1, X2)

Mounting: Inside or outside of moisture sensor

Start / stop switch inputs:

Input signal: Stop = 0V
Start = +24V ($\pm 10\%$)

Isolation: Galvanic isolation provided

FMG	FMG 13 rue du clos d'en haut F 78700 Conflans Ste Honorine Tel. +33134900021 Fax +33134901566	Änderung:	Seite: 30/35	Dokument: D100485
------------	--	-----------	-----------------	-----------------------------

100485.doc

connection: Pluggable clamping bar (X3)

Relay outputs:

Type: Two relays, one switching contact each

Rating: 60V AC/DC 1A max.

Connection: Pluggable clamping bar (X1, X2)

Analogue signal outputs:

Moisture signal: 0-10V (0-20mA / 4-20mA, optional)

Connection: Pluggable clamping bar (X3)

Temperature signal: 0-10V (0/4-20mA, optional)

Temperature measurement: -45°C bis +199,9°C

-50°C = 0V, +200°C = +10V

(40mV / °C)

Connection: Pluggable clamping bar (X3)

Digital serial interfaces:

USB interface: Transmission of measured values and control of the FMP-2 by PC or SPS, by the help of custom designed software.
Simple DOS program „FMP2TEST“ available.

RS485 interface: Galvanic isolation provided.
Connection of very long cables possible.
Transmission of measured values and control of the FMP-2 by PC or SPS, by the help of custom designed software.
Simple DOS program „FMP2TEST“ available.
Baud rate: 9600

FMG	FMG 13 rue du clos d'en haut F 78700 Conflans Ste Honorine Tel. +33134900021 Fax +33134901566	Änderung:	Seite: 31/35	Dokument: D100485
------------	--	-----------	-----------------	-----------------------------

100485.doc

Further specifications:

Face frame: W x H: 213 mm x 125 mm
 Mounting depth: approx. 130 mm, without clamping bar
 approx. 160 mm, including clamping bar
 Operating elements: Touch screen, IP67
 Display: Monochrome LCD graphic display screen, backlighted
 Resolution of display: 320 x 240 pixels
 Viewing direction of display: 12 o'clock

18. Installation hints:

The FMP-2 is designed to be installed into a control panel. It has to be protected against humidity and dirt. A rubber gasket supplied with FMP-2 seals the device at the control panel. The ambient temperature must be within the limits. Also, the device must be aerated to allow the remove of internally dissipated heat.

Due to the design the FMP-2 needs an external mains switch.

19. Pannel assembly dimensions

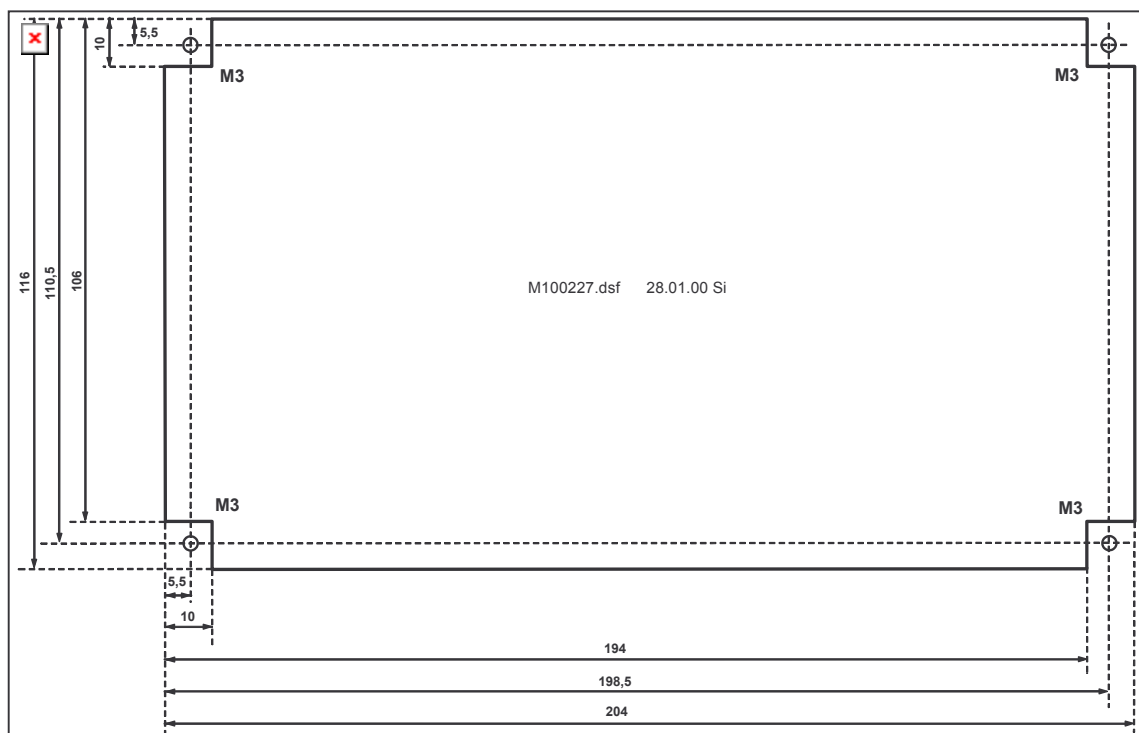

100485.doc

20: Backside of FMP-2 / Pin assignment:

Here are two examples of the backside of FMP-2:

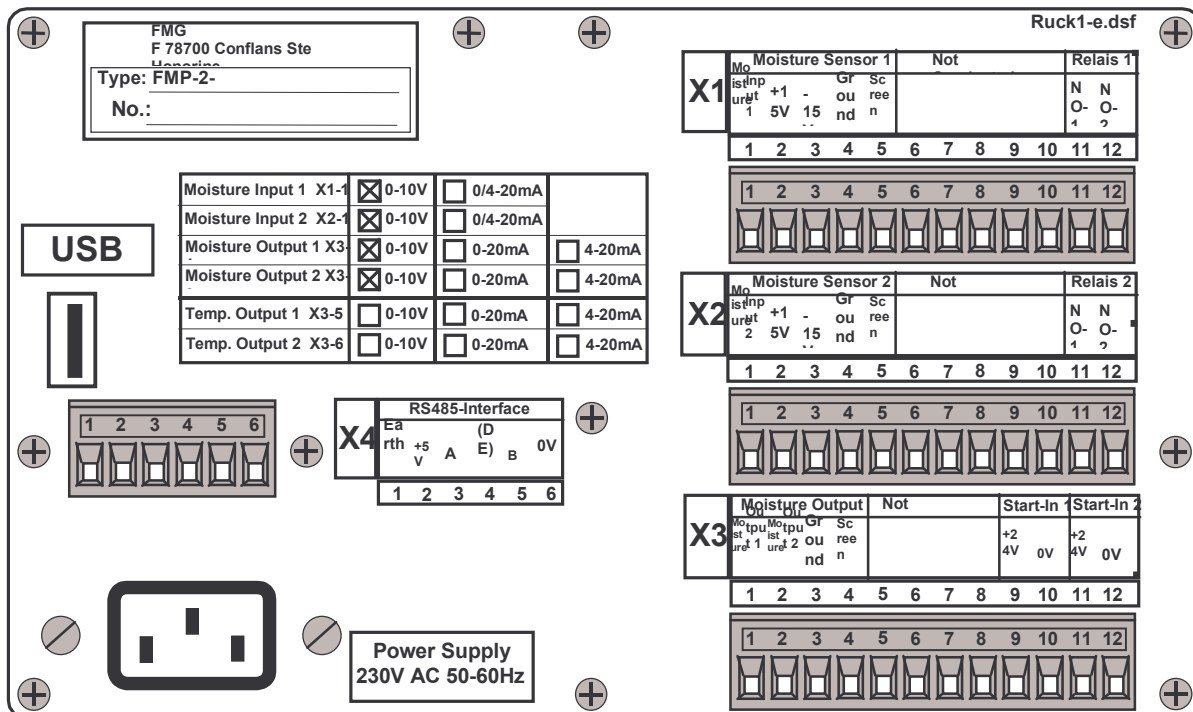

Backside of FMP-2: Two channel version, 230VAC mains, without PT100-option

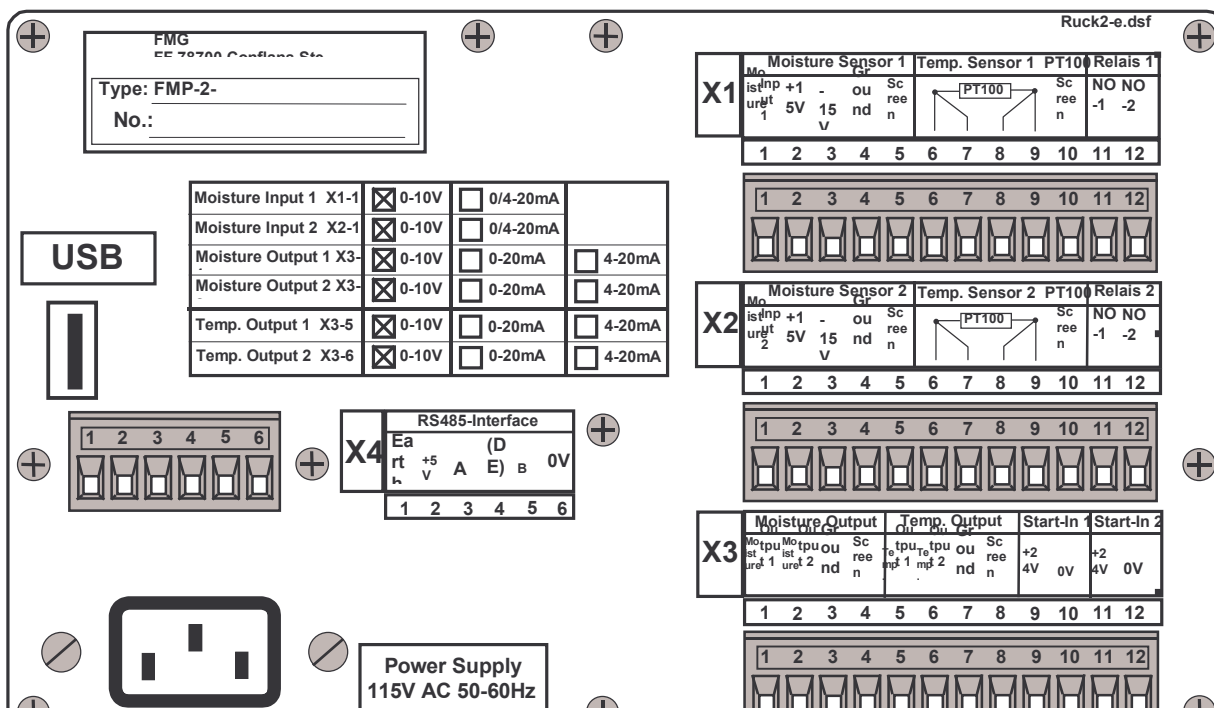

Backside of FMP-2: Two channel version, 115VAC mains, PT100-option

FMG	FMG 13 rue du clos d'en haut F 78700 Conflans Ste Honorine Tel. +33134900021 Fax +33134901566	Änderung:	Seite: 33/35	Dokument: D100485
------------	--	-----------	-----------------	-----------------------------

100485.doc

21: Quickstart: Setting up a curve:

In the following we want to carry out a „static“ calibration on channel 1. Then, at the end of this chapter, we will briefly discuss the „dynamic“ calibration. (Please have a look at the „summary of menus“ on page 11, to find the various submenus.)

Precalibrating the moisture sensor:

Before the moisture sensor can be used for measuring of moisture and feeding the FMP-2 with its signal, it must be precalibrated, to guarantee, that the sensor signal is 0V at minimum moisture and 10V at maximum moisture. If the moisture sensor isn't precalibrated by the factory for a certain material (e.g. „sand“) but contains some trimmers for the precalibration (sensors with option „T“), then the „voltage measurement“ („current measurement“) mode of „product“ menu allows to easily precalibrate the moisture sensor:

Adjust the „0“-trimmer so that the moisture sensor will emit 0V (0/4mA) at minimum moisture of material and adjust the „%-“trimmer so that the moisture sensor will emit 10V (20mA) at maximum moisture of material.

Preparing the samples of material:

For the calibration we need three samples of material of different moisture, prepared in plastic (!) buckets. To keep the electrical field of moisture sensor entirely within the material during the measurement, the material in the buckets should be at least 8-10cm thick, so that you will need at least 2 liters of material in each bucket.

First, we kiln-dry some material of the three samples and determine the moisture by the help of following formula:

$$\text{moisture [\%]} = ((\text{moist weight} - \text{dry weight}) / \text{dry weight}) \times 100\%$$

Alternatively, we can use the moisture analyzer „MB45“ (ARNOLD-Automation) to determine the moisture of the three samples.

Above formula and the kiln-drying allows us to determine the reference moistures, which we should write down directly on the according buckets, now, to avoid any confusing later on.

FMG	FMG 13 rue du clos d'en haut F 78700 Conflans Ste Honorine Tel. +33134900021 Fax +33134901566	Änderung:	Seite: 34/35	Dokument: D100485
------------	--	-----------	-----------------	-----------------------------

100485.doc

Attention:

Take care, that the moisture of samples does not change during the whole calibration process!

Hint: For the very first experiments you can simulate samples of different moisture by pressing your hand more or less strong onto the sensitive surface of moisture sensor. By the help of „voltage measurement“ („current measurement“) of FMP-2 you can see how the signal is changing.

Setting up a curve:

Being in the „main menu“, press the „**Product channel 1**“ button. Then, press the „**EDIT**“ button. Now, unlock the „calibration“ menu by the following sequence of keystrokes:

First, press the left arrow button (-), then the right arrow button (+), again the left arrow button (-) and again the right arrow button (+).

Before entering calibration points for the first time, you must configure the curve by pressing the „**Set up of curve**“ button in the unlocked „calibration“ menu, first. So, please enter the curve name and a suited scale, by the help of „**ABC**“ and „**123**“ buttons. After entering of each data press the „**ENTER**“ button!

Press the „**ESCAPE**“ button to go back to the „calibration“ menu.

Now, we can enter the calibration points by the help of „**0/3**“ button, which allows the calculation of average of up to three measurements in a row:

So, please stir the material of the first bucket and press the moisture sensor onto the surface (by a pressure of about 3kg) while slightly rotating the sensor a bit, to remove all eventually entrapped air. Press the „**0/3**“ button to store the measurement. (You will notice that the button becomes renamed to „1/3“ afterwards, to indicate that one measurement has already been stored.)

Then, stir again the material of the bucket and press the moisture sensor onto the surface as explained above. Press again the „**1/3**“ button to store the second measurement.

FMG	FMG 13 rue du clos d'en haut F 78700 Conflans Ste Honorine Tel. +33134900021 Fax +33134901566	Änderung:	Seite: 35/35	Dokument: D100485
------------	--	-----------	-----------------	-----------------------------

100485.doc

Then, stir again the material and store the third measurement by again pressing the „**2/3**“ button.

Right after that, the field „reference value“ is highlighted, to remember you to enter the reference moisture, gained by the earlier kiln-drying.

Now, take the second and third bucket and repeat the entering of second and third calibration point, as explained above.

To display the whole calibration curve now, press the „**Calibration curve**“ button. Or press the „**Calibration table**“ button to display the calibration table.

Going back to the „main menu“ you will see now the correct moisture displayed on the screen.

„Dynamic“ calibration:

The calibration with samples being prepared in the plastic buckets might not exactly represent the actual process of measuring, means the finally installed sensor might give slightly different readings. For instance, because the moisture sensor is fit in a metal surface or metallic objects of the installation come near to the sensitive surface of moisture sensor.

So, to obtain highest precision it might be needed to carry out a „dynamic“ calibration with the finally installed moisture sensor, to refine the earlier „static“ calibration.

The dynamic calibration is done by the help of „**sil0**“ button, which you will find left of „**0/3**“ button in the unlocked „calibration“ menu. As long as the „**sil0**“ button is pressed, the measurement is recorded and continuously averaged.

To gain the reference moisture of this calibration point, you must take a sample of the material, which was measured during the pressing of „**sil0**“ button, of course. Then, kiln-dry it and calculate the reference moisture by the help of above formula.